

EVOLUTION

Motic®

MORE THAN MICROSCOPY



BA310E | **ADVANCED
BIOLOGICAL
MICROSCOPE**

BA310E ADVANCED BIOLOGICAL MICROSCOPE



Motic is committed to the concept of continuously improving its models by careful listening to the demands of the microscope users. The successfully established BA310 model was no exception, and with the newly developed BA310E model, once again Motic has challenged itself to stride ahead of the competition.

The BA310E is a microscope designed for better usage and better longevity in daily work of **Universities, Clinics, Laboratories** as well as any biomedical application requiring **quality optical performance**.

The BA310E model introduces **significant improvements** both in optical and mechanical aspects, while keeping flexibility of applications. The **new rackless stage** concept **without prominent gear rack** allows an even more convenient use of the x/y movement, while increasing user safety. An expansive travel range of 80x55mm, in combination with a new specimen holder for better grip to the glass slides, allows a large throughput of samples.

Keeping the **Full-Koehler illumination** feature, the new model BA310E has an easy **interchangeability** of its **6V/30W Halogen bulb with LED modules** of different colour temperatures (**4500K, 6000K**), accepted by the Halogen lamp socket. Contrast methods like **Phase contrast, Polarization or Dark field** can easily be performed due to sufficient power resources.

A set of **new EC-Plan Achromat objectives** with **extended working distances** for sample protection has been derived from the flagship model BA410. Motic's CCIS® Infinity concept with multi-layer coated lenses incorporates a **fully corrected intermediate image** for digital access, delivering professional optical performance even in routine work.

The complete BA310E microscope is manufactured in **accordance with** current **RoHS** standards and thus prohibits contact to lead-containing materials.

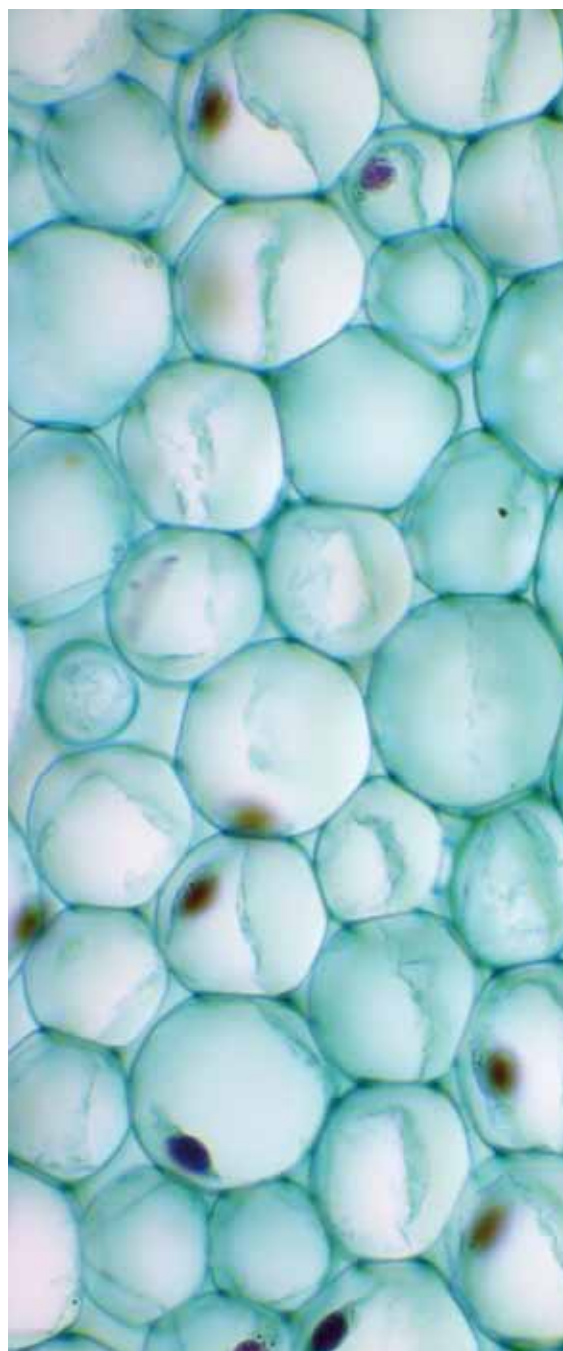

New EC Objectives

Motic's Elite model's **new** generation of **EC Plan Achromat objectives** set a new price-performance standard in optical quality. With significantly improved **field flatness** and **resolution**, the EC optics offer **superior colour fidelity and contrast** through multi-layer coated glass lenses.

In cooperation with the tube lens, a **fully corrected intermediate image without any coloured fringes** is delivered. So the Trinocular BA310E gives access for an even better imaging and improved digital output quality for professional results.

Significantly **increased working distances** of objectives greatly **reduce contamination** when changing from oil lenses to dry lenses, while protecting lenses in rough usage.

The complete production process of these CCIS® objectives, derived from the flagship model BA410, follows the **RoHS standards for lead-free manufacturing**.

Besides the standard collection of Bright field lenses, a **new series of Non-Cover-Glass (NCG)** objectives are also available. These lenses are designed for sample preparation without placing a final cover slip on top. This kind of preparation is e.g. performed in Auramine O staining of Tuberculosis samples.



Magnification	N.A.	W.D.(mm)
EC Plan 4X	0.10	15.90
EC Plan 10X	0.25	17.40
EC Plan 20X	0.45	0.90
EC Plan 40X	0.65	0.50
EC Plan 60X	0.80	0.35
EC Plan 100X-oil	1.25	0.15

Illumination

The importance of **LEDs** as **safe** and **long-term illumination sources** has become increasingly the norm in clinical microscopy environments. Nevertheless, experienced users may still prefer the “warm” Halogen illumination with a large portion of long wavelengths. To cover this situation, Motic has implemented a **full interchangeability between its Halogen and LED light sources**.

Coming with a **standard 6V/30W Halogen bulb**, the **BA310E** model lamp socket **also accepts a new LED module**, which can be inserted instead of the Halogen bulb. The choice of (2) different color temperatures (**4500K, 6000K**) enhances illumination options in a user-friendly way.





The following reticles are available:



Graduated
linear hair point
0.1mm/10mm



Graduated
cross hair point
0.1mm/10mm



Plain cross hair

Eyepiece Tubes

Designed with an **ergonomic viewing angle of 30°** and incorporating an **extended interpupillary distance of 48-75mm**, the BA310E eyepiece tubes **guarantee fatigue-free viewing for hours**. A large **field of view (20mm)** enables fast and comfortable screening.

All standard eyepiece tubes offer an extended **“butterfly” swivel** adjustment to increase the viewing height to accommodate individual user’s positioning. The Trinocular tubes allow digital documentation by using a wide variety of digital cameras, with **20/80** or optional **0/100** light splits for the Trinocular exit.

Eyepieces

The new standard eyepieces, **N-WF 10X/20** with **high eyepoint** for eyeglass wearers, made of high quality optical glasses with multi-layer coating, provide consistent diopter adjustment for both eyes. This enables perfect usage of reticles for measuring and counting.

Lockable eyepieces may prevent inadmissible removal and confirm Motic's dedication to **real-life requests**.

Magnification	F.N.(mm)
Widefield N-WF 10X	20
Widefield N-WF 12.5X	18
Widefield N-WF 15X	16



Condenser

To ensure the best possible illumination quality, the BA310E has a built-in **full Koehler setup** with a Field diaphragm for handling of delicate sample structures.

The **standard condenser with NA 0.9/1.25** and slot for Phase / Dark field slider is a basic component of the BA310E packages, while the full integration of the instrument in Motic's BA Series provides an **optional LWD condenser** (for full Koehler quality while using high counting chambers) as well as a **Turret Phase condenser** to match all possible Phase objectives.

Rackless Stage

The **new rackless stage** enables a convenient x/y movement of the sample without prominent gear rack interference; while a new specimen holder design gives a soft but solid grip to the glass slides.

The BA310E models offer a **left or right hand control** with a **travel range of 80 X 55mm**, with a **stage area of 180mm x 170mm** giving sufficient place for the optional 2-slide holder for large throughputs of samples. The hard coated surface of the stage is resistant against routine usage abrasion, ensuring a long life-time of the microscope.

Multi Viewing Devices

To share the complete visual information of the eyepieces, the BA310E Series offers **multi-viewing devices**. There are **two options** available, depending on the teaching situation in the laboratory: **face to face or side by side**. The standard field of view of 20mm ensures that maximum information will be given from the teacher to the learner. Depending on the sample staining, the user may activate a **built-in LED pointer** in red or green for demonstration of defined areas.



Polarization

Convenient and easy, the **BA310E polarization** system consists of a **polarizer**, placed on top of the collector lens, and the **analyzer**, placed between the eyepiece tube and the microscope body.

Phase Contrast and Dark field

For Phase Contrast and Dark field, the BA310E offers a variety of solutions, following different demands of price and flexibility.

For single Phase contrast lenses, the **standard slot condenser** may carry a Phase slider for the objective magnifications from 10X up to 100X. Due to a complete harmonization of the Phase rings, all **EC-H lenses** from BA410 program (positive & negative Phase) can be used.

A **Dark field slider** can be used for 4X up to 40X lens magnification (more precise: N.A. max. 0.65). For more advanced Phase contrast flexibility, a **Turret condenser** with phase rings for **all objectives, including a DF stop**, is also available. Like the slider solution, the turret carries light rings matching both **positive** and **negative phase** lenses.





Simple switching from Bright field to Fluorescence

Sleep mode

Intensity control

LED Fluorescence Modules

LEDs as a **light source** for Fluorescence display a number of **advantages**. **No adjustment** is needed to achieve maximum efficiency in Fluorescence excitation. Plug-and-Play is the principle. Observation of the sample can be started immediately as there is **no warm-up period**. A convenient **intensity adjustment** protects the sample from bleaching. From an **environmental perspective**, no mercury disposal has to be considered. Motic's **Fluorescence illuminator** contains an LED light source as well as a selected filter combination with excitation, dichroic and barrier filter. The module is placed as an **add-on between stand and eyepiece tube**.

For **user safety** reasons, the LED light source cannot be activated unless mounting of the Fluorescence illuminator is done properly. Additionally an **IR-sensor** detects the user and **turns off the Fluorescence** automatically when the microscope is left. The power is reactivated after returning to the instrument. By adding the Fluorescence module, a **fast change from Bright field to Fluorescence** and vice versa is possible as well as a simultaneous use of both illuminations.

CCD Adapter

All new CCD adapters follow the **ISO standard** of 38mm diameter, giving improved optical performance to enhance imaging quality. The appropriate adapter has to be chosen in relation to the chip size of the used digital camera. The following "magnifications" are available: 1X, 0.65X, 0.5X and 0.35X.

Anti-Fungus Design

To protect the system from fungus growth in high-humidity environments, an **anti-fungus treatment** is applied to all parts of the microscope, especially the optical components (objectives, eyepieces).

The following LED/Filter combinations are available:

455nm LED module

Tuberculosis diagnosis with Auramine O staining

Auramine O

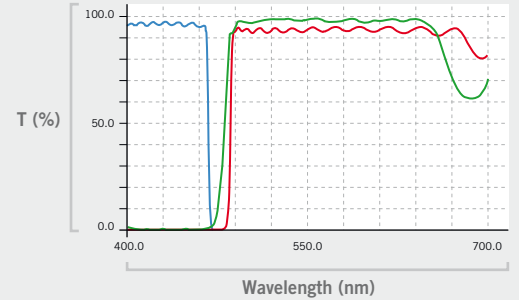

Wavelength (nm)

	Wavelength (nm)
Exciter	470Sp
Dichroic	480DRLP
Barrier	485LP

470nm LED module

This module offers a FITC detection

FITC

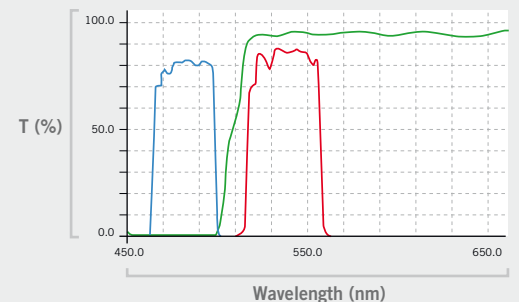

Wavelength (nm)

	Wavelength (nm)
Exciter	480/30x
Dichroic	505DCLP
Barrier	D535/40m

470nm LED module

This module offers a blue excitation combined with a long pass barrier filter

Blue Excitation

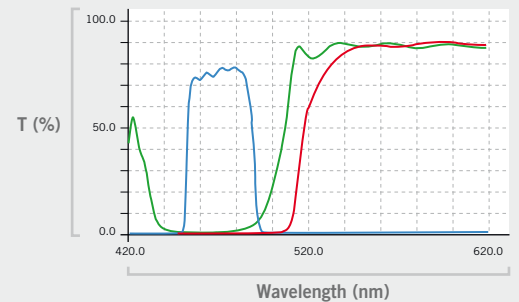

Wavelength (nm)

	Wavelength (nm)
Exciter	470/37
Dichroic	505LP
Barrier	515LP



Documentation

The importance of documentation has expanded into every aspect of microscopy. The BA310E is accessible by the traditional method (photomicrography) and the more flexible C-mount camera approach.

Standard Photomicrography

The traditional use of a **single lens reflex camera** (today mostly digital) requires the Trinocular version of the BA310E. The adaptation of the camera consists of a **mechanical adapter** combined with a **photo eyepiece** (2.5X or 4X).

The necessary **T2 adapter** referring to the camera model's bayonet is supplied by the **camera manufacturer**. **This setup delivers high resolution images of small fields**. Live images can be supplied in most cases by the camera's manufacturer software.

Digital Documentation

A more convenient setup is provided through Motic's philosophy of easy image digitization. The combination of the BA310E with a member of the **Moticam** series of digital C-mount cameras delivers **excellent live images**, which can easily be stored for future usage. All new CCD adapters follow the **ISO standard** of 38mm diameter. The appropriate adapter has to be chosen in relation to the chip size of the used digital camera. **All Motic cameras come equipped with software** to transform the BA310E into an analysis and documentation station.

Motic offers a complete range of digital cameras starting with a basic resolution of 1.3MP up to 10MP (CMOS technology). The Research grade Moticam Pro Line (CCD technology), with a maximum of 5MP, including Monochrome and Cooled versions, is dedicated to professional demands for sensitivity and colour fidelity. All Moticam cameras deliver sharp live images with easy post-capture handling.

For limited bench-top space, Moticam 580 and 580INT are the ideal solutions. Both cameras allow capturing 5MP images and 1080p videos onto an SD card. The HDMI output delivers High Resolution images without computer. The Moticam 580INT is an intermediary camera, placed between microscope body and eyepiece tube. A 10" LCD monitor is attached onto the camera's housing to share the imaging result.

For further details on our range of cameras, as well as the different adapters, please contact your nearest Motic office or your local authorized Motic reseller.

BA310E Standard Specifications

Model	BA310E
Optical System	Color Corrected Infinity Optical System [CCIS®]
Observation Tube	Widefield binocular 30° [F.N.20] Widefield trinocular 30° [F.N.20] - light distribution 100:0/20:80 Widefield trinocular 30° [F.N.20] - light distribution 100:0/0:100
Interpupillary distance	48-75mm
Nosepiece	Reversed quintuple
Objectives	CCIS® EC Plan 4X, 10X, 20X (optional), 40X, 60X (optional) and 100X-Oil
Rackless Stage	180 x 170 mm surface, 80 x 55mm movement, coaxial controls
Condenser	N.A. 0.9/1.25 Abbe condenser with slider slot
Focusing Block	Brass gears. Z-Axis movement with 20mm stroke; Fine focus with 2µm minimum increments, coarse focus with torque adjustment Stage lock for high samples, free definable
Illumination	Built-in transmitted 6V/30W Halogen Koehler illumination or 3W LED Koehler illumination (6000K & 4500K)

BA310E Schematic Diagrams (units: mm)

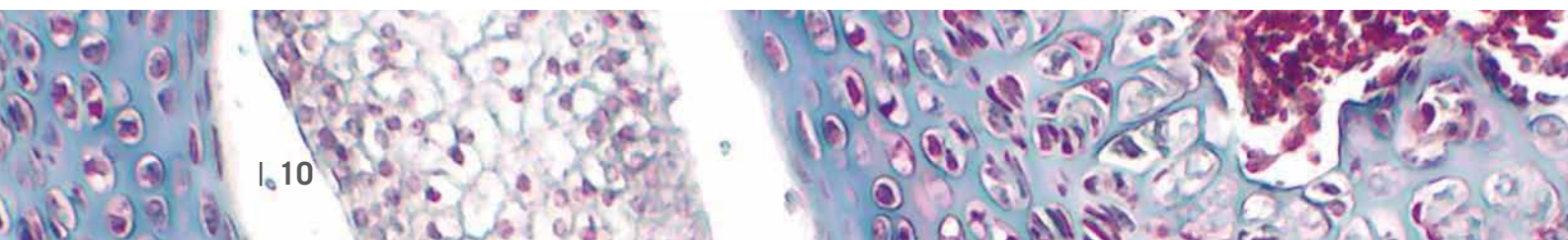
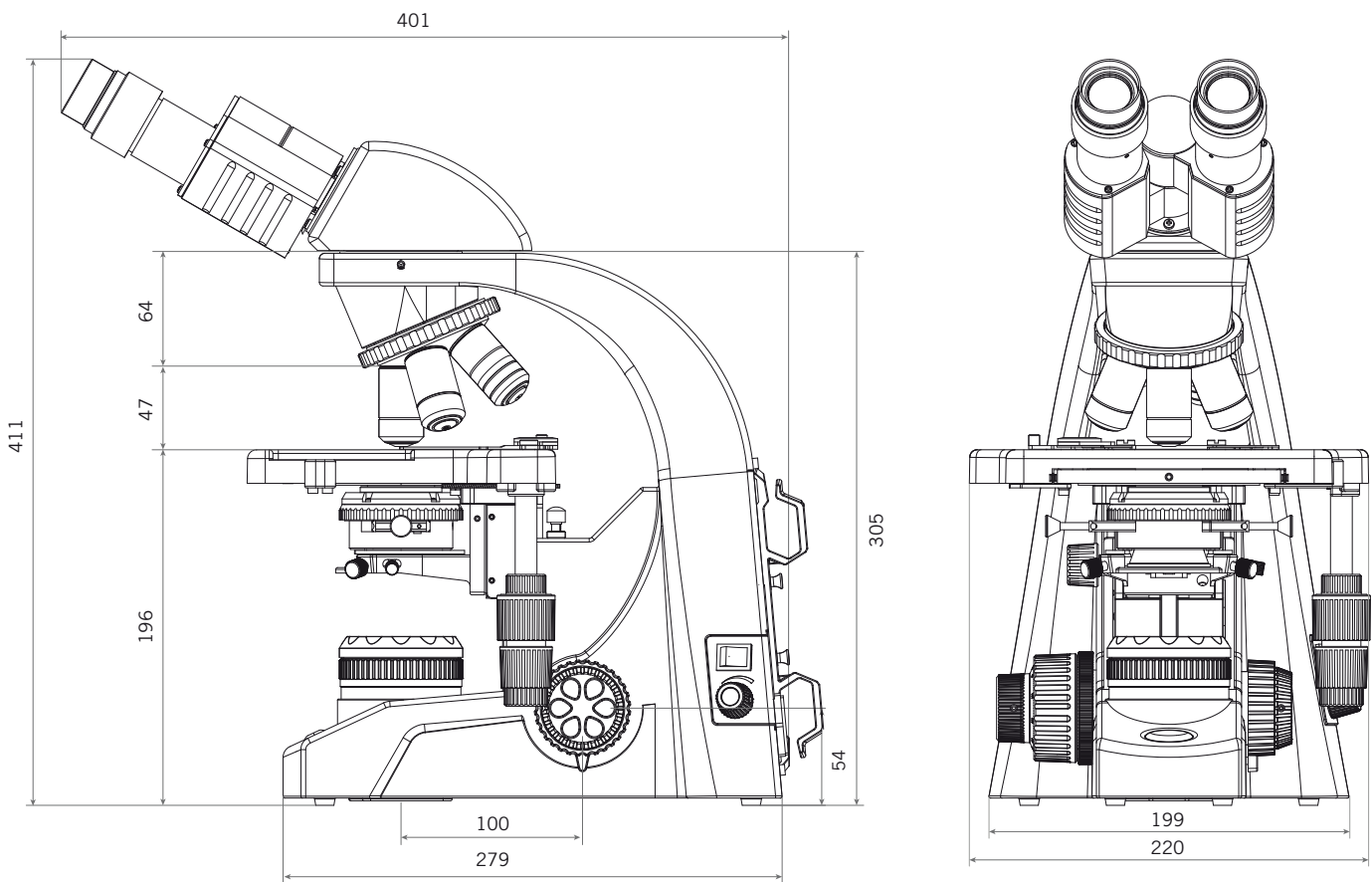

BA310E / System Diagram

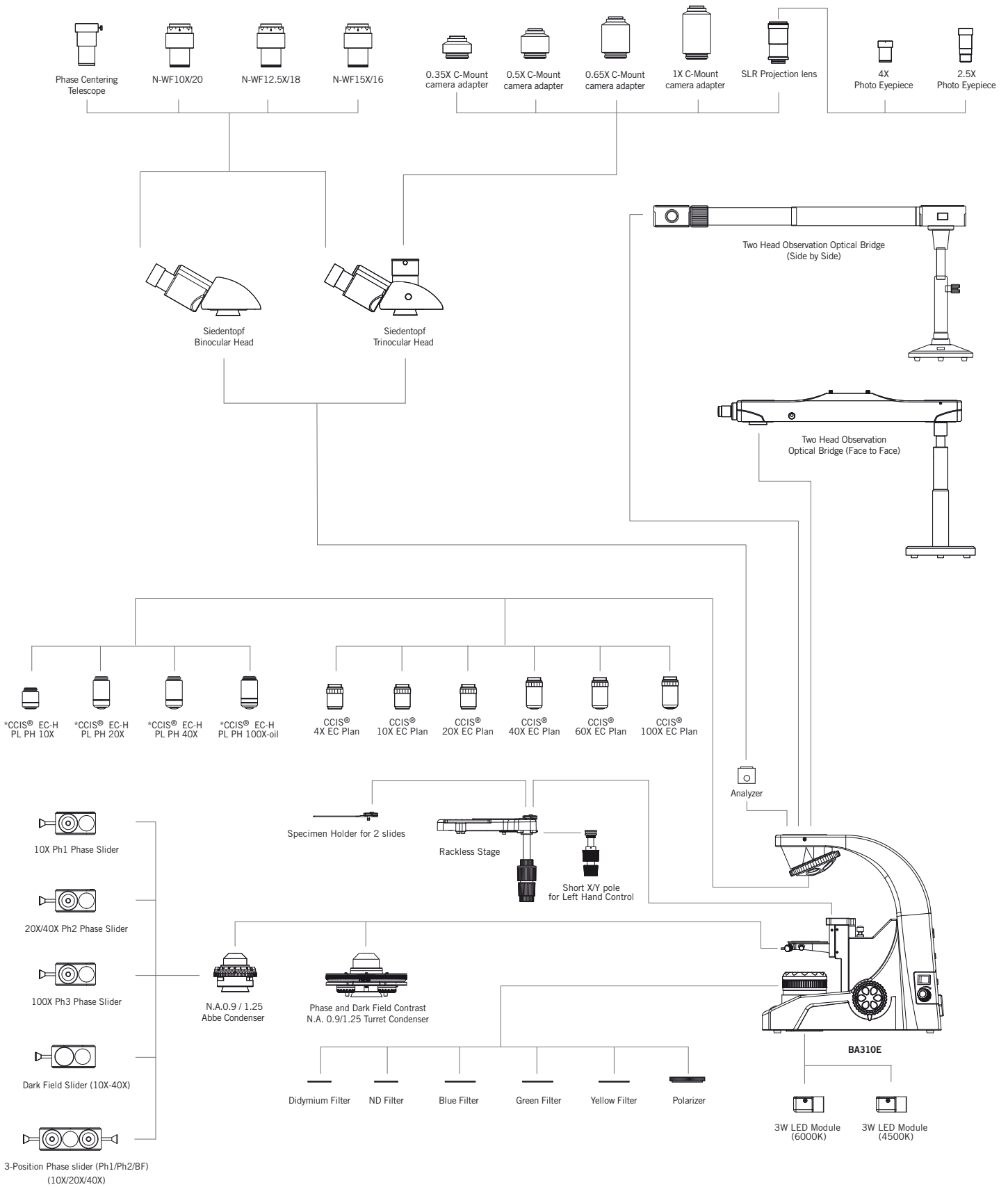

* Standard: positive phase; negative phase available on request



Motic®

www.moticeurope.com

Motic Instruments (CANADA)

130 - 4611 Viking Way. Richmond, BC V6V 2K9 Canada
Tel: 1-877-977 4717 Fax: 1-604-303 9043

Motic Deutschland GmbH (GERMANY)

Christian-Kremp-Strasse 11, D-35578 Wetzlar, Germany
Tel: 49-6441-210 010 Fax: 49-6441-210 0122

Motic Incorporation Ltd. (HONG KONG)

Rm 2907-8, Windsor House, 311 Gloucester Road,
Causeway Bay, Hong Kong
Tel: 852-2837 0888 Fax: 852-2882 2792

Motic Spain, S.L. (SPAIN)

Polígono Industrial Les Corts, Camí del Mig, 112
08349 Cabrera de Mar, Barcelona, Spain
Tel: 34-93-756 6286 Fax: 34-93-756 6287

* **CCIS®** is a trademark of Motic Incorporation Ltd.

**Motic Incorporation Limited Copyright © 2002-2013.
All Rights Reserved.**

Design Change :

The manufacturer reserves the right to make changes in instrument design in accordance with scientific and mechanical progress, without notice and without obligation.



March 2013
Designed in Barcelona (Spain)

